

Optimizing Clean Power Everywhere

Optimizing the Level of Renewable Penetration in a Hybrid System

Dr. Peter Lilienthal

EUEC 2015

February 17, 2015

1790 30th St, Suite 100, Boulder, Colorado 80301, USA

<http://www.homerenergy.com> • +1-720-565-4046

HOMER[®] Software

- Industry standard for hybrid micro-grids
- Design optimization
- Decision analysis
 - Conventional resources
 - Renewable resources
 - Storage
 - Load Management

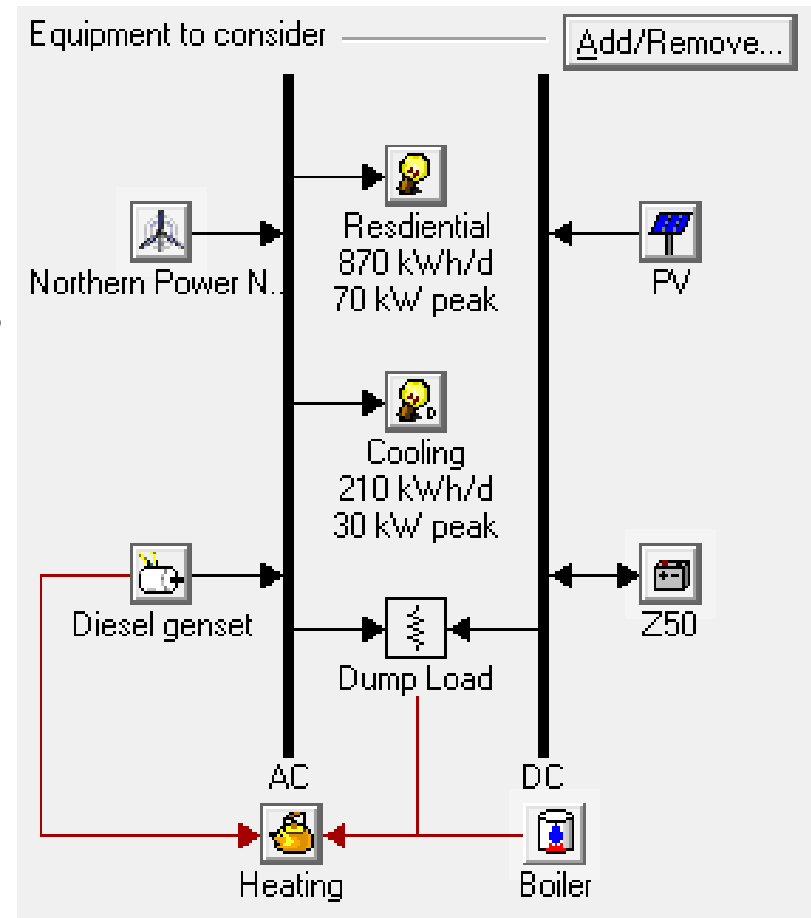

HOMER Analysis Layers

- Hourly Energy Balance
- Chronological Simulation
 - Loads & resources vary continuously
- Optimization
 - Find the least cost solution
- Sensitivity Analysis
 - The data is never “good enough”.
 - What if....?

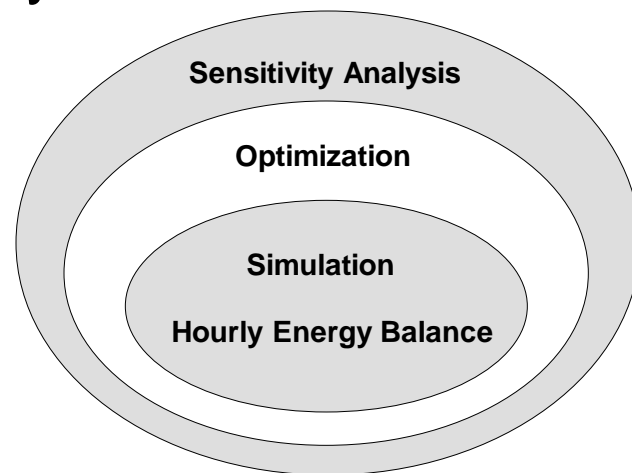

Optimal System Design

What makes sense where?

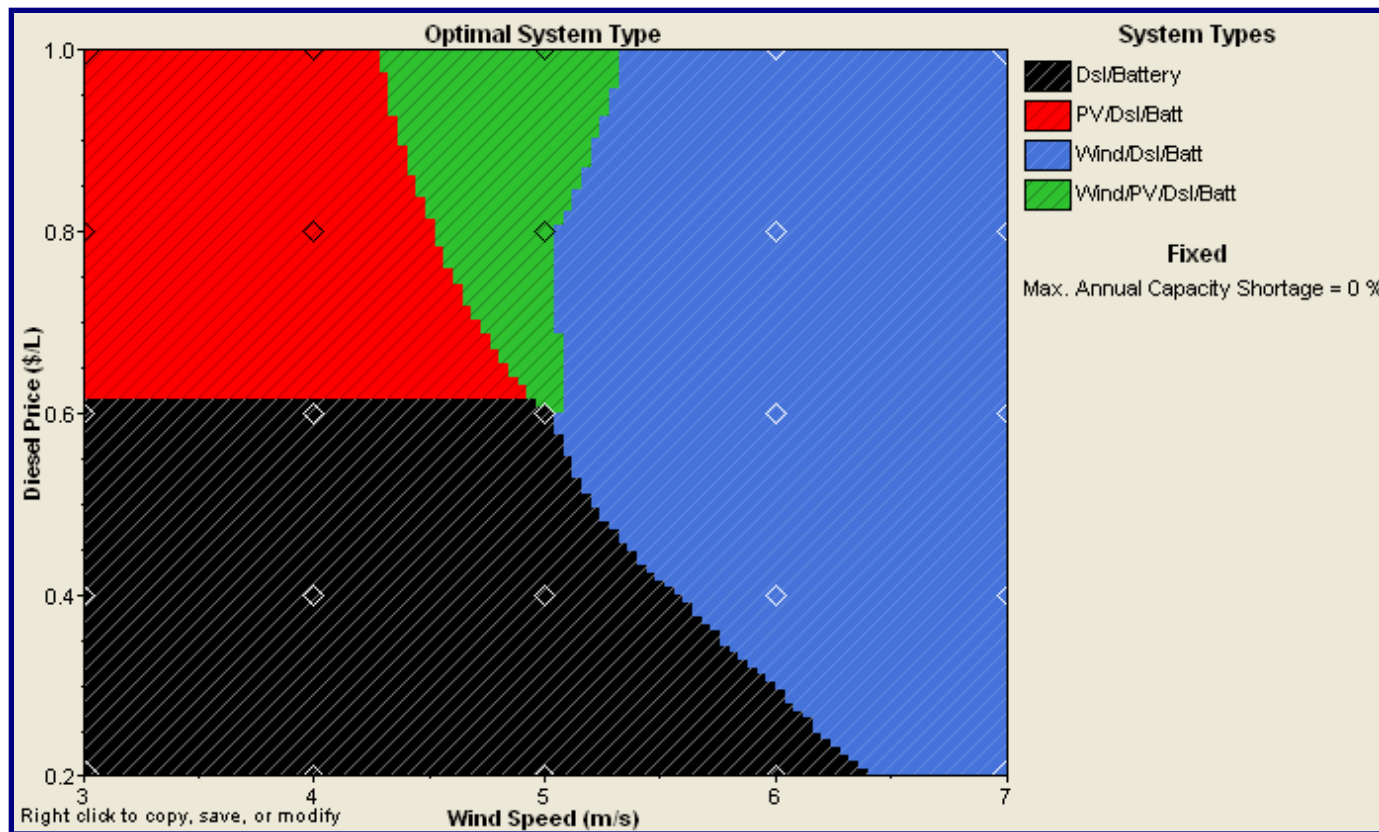

HOMER

- NREL: 1992-2009
- Original developers now at HOMER Energy
- >120,000 users in 193 countries

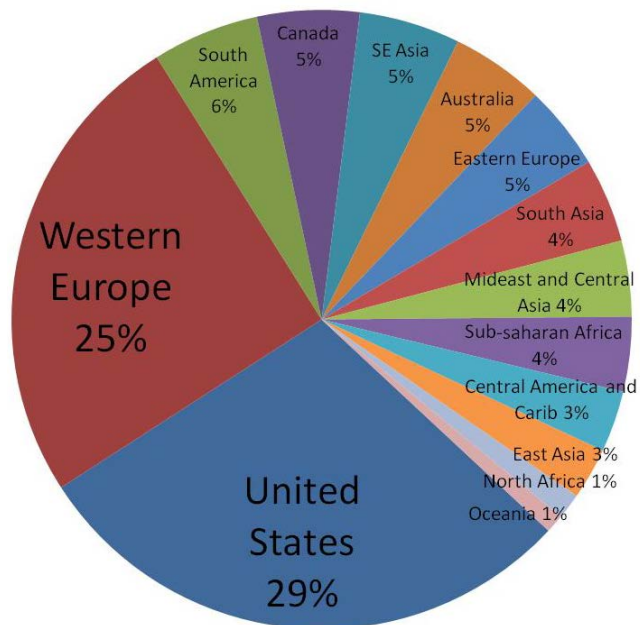

New users per month

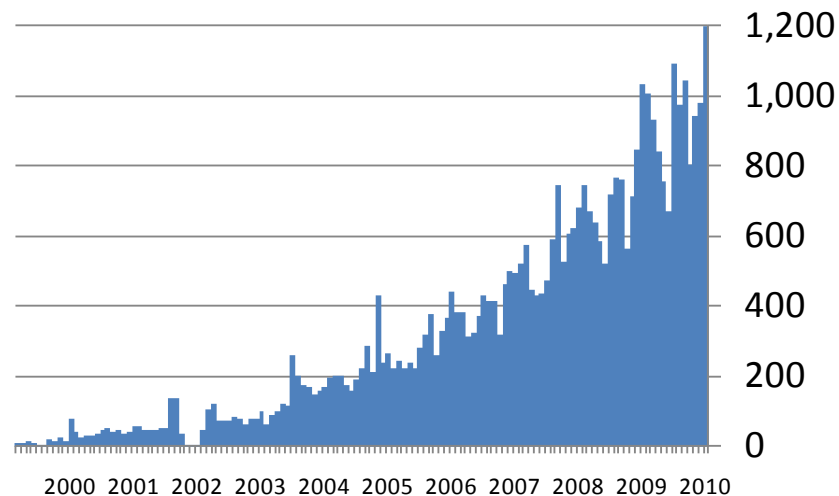

A confused mind says “No!”

Solar

Fuel Cells

Wind

Micro-turbines

Hydro



Micro-grids

Geothermal

Demand
Response

Biomass

New Storage Techs.

Load Management

Electric
Vehicles

Smart grids

What is best?

- Depends on the application
 - Resources
 - Loads
 - Equipment prices
 - Equipment performance

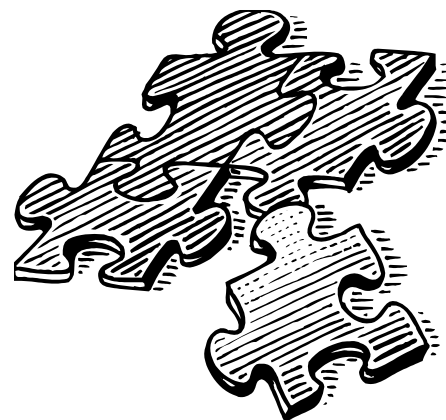

- **HOMER fits the pieces together**
 - Bridge technical & economic analyses

HOMER bridges different worlds

Renewable Advocates

Power
Engineers

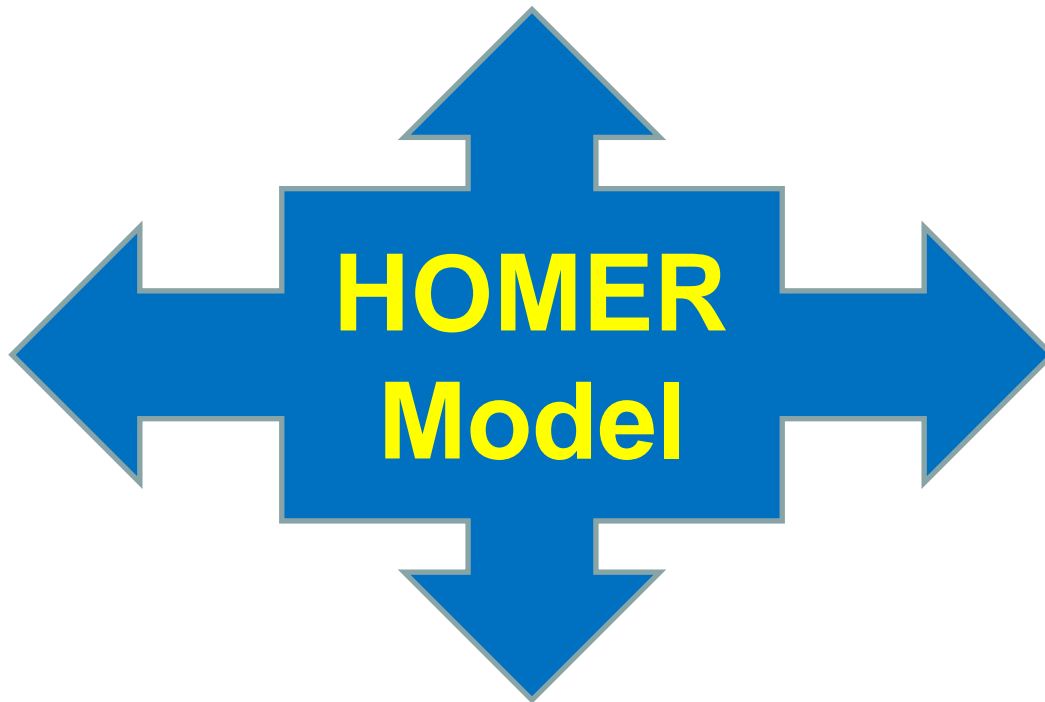

Financiers

Utility Operators

HOMER as a communication tool

www.homerenergy.com

Clean Power Evolution

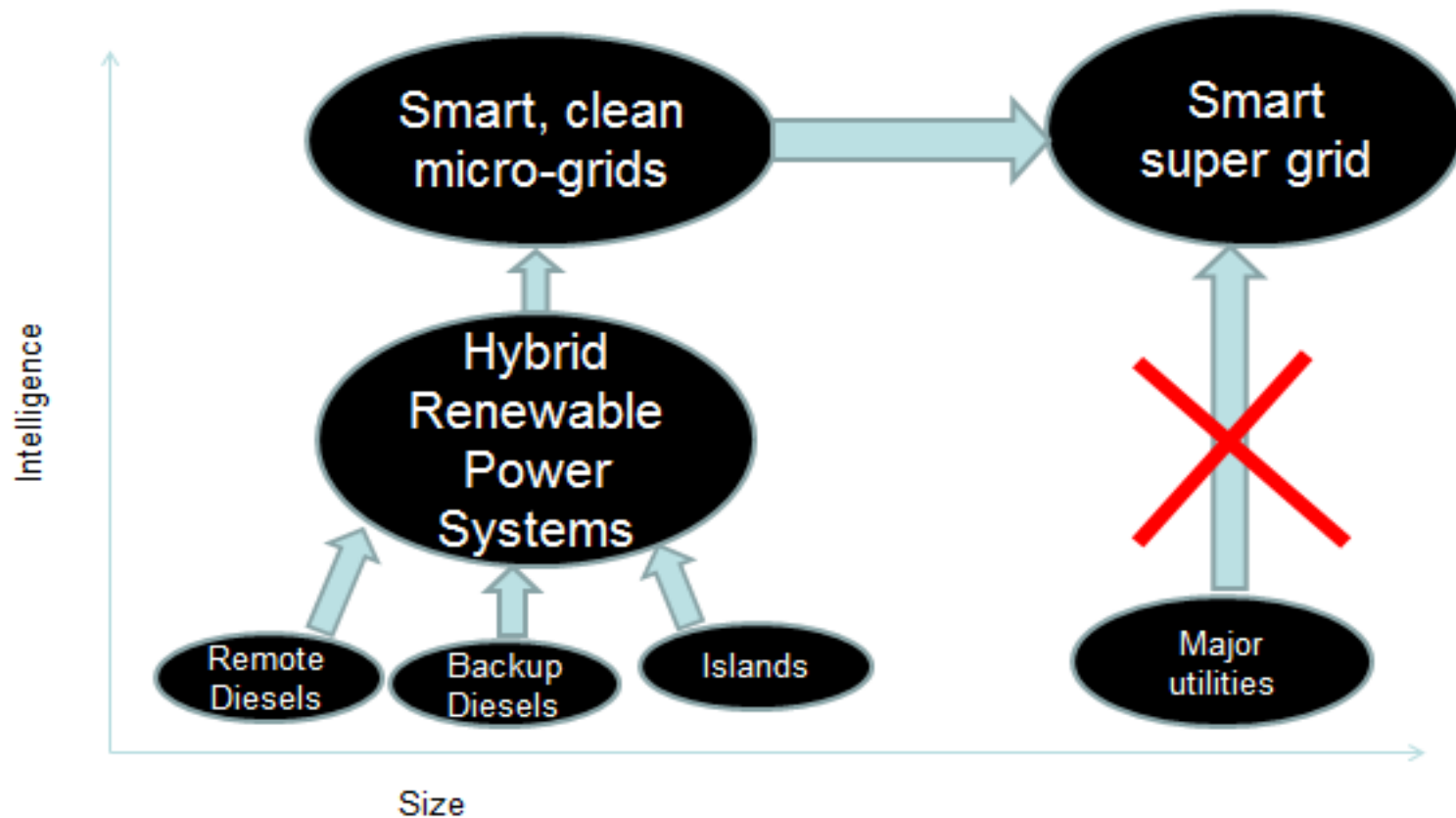

- Smaller systems

- Liquid fuels from oil
- High renewable penetrations

- Large utilities

- Security obstacles
- Regulatory obstacles

Constraints to penetration

- Ramp rates
 - Geographic diversity for short term ramps
 - Flexible generation mix
- Voltage fluctuations
 - Local phenomenon
- Minimum load constraints
 - Operating reserve constraints

Level of renewable Penetration

| | |
|------------------|--|
| Low | No Special Controls |
| Medium | Control excess renewables |
| High | Re-dispatch conventional generators |
| Very high | Operate diesel off |

Five different penetration metrics

- Fuel savings
- % of energy
- % of peak load
- % of capacity
- Max instantaneous



St. Paul, Alaska

Controlling High RE Penetration

- Curtailment is simplest solution
- Storage sounds simple
 - Expensive, but has other values
- Load management
 - Secondary loads
 - Deferrable loads
- Flexible fuel-fired generation
- Power electronics

Penetration Analysis from HOMER

Cost of Electricity Based on Renewable Penetration

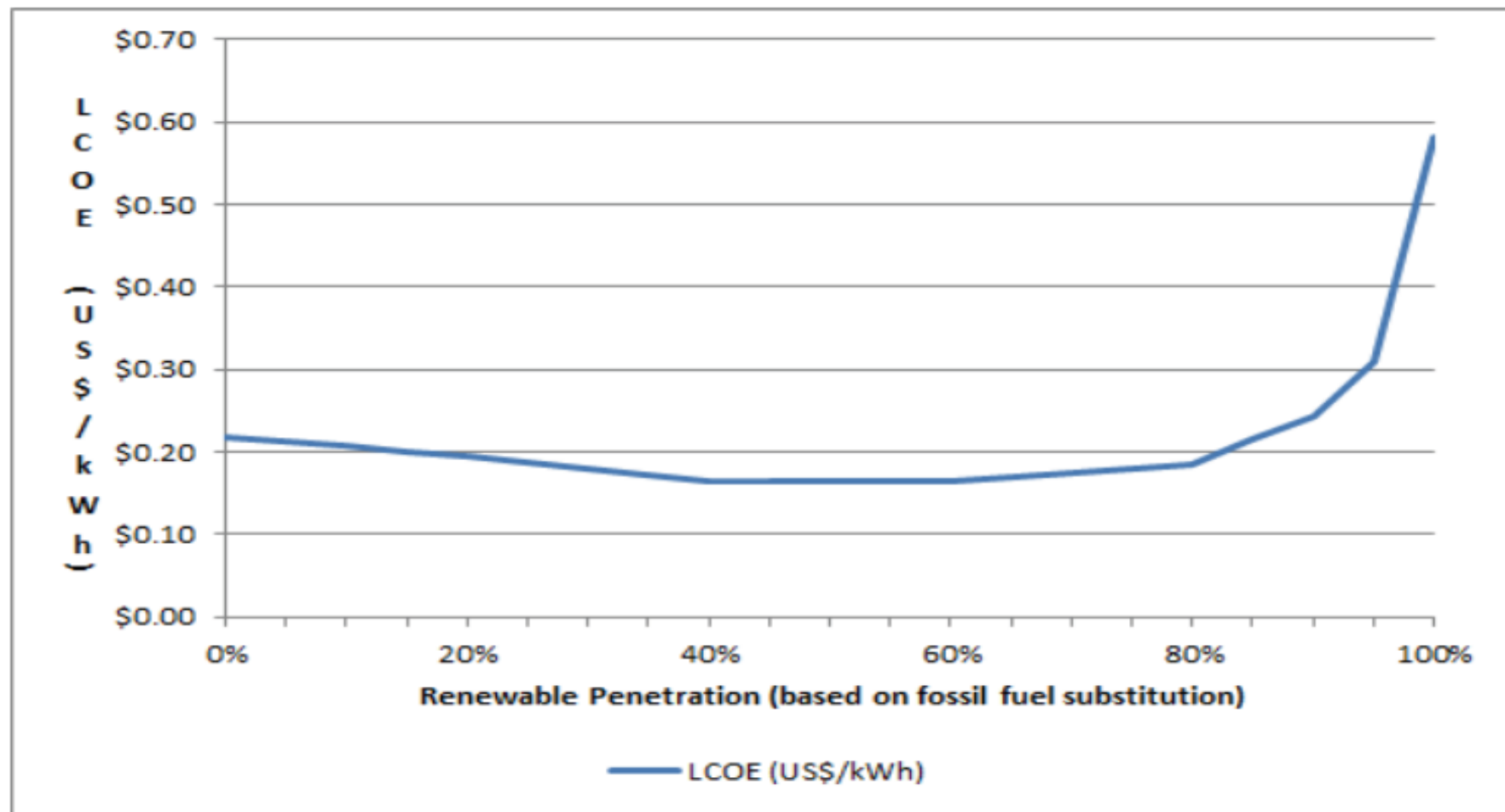

Lessons from the Remote Market

- What to do when the wind blows too strongly
 - Secondary loads
- What to do when it stops too abruptly
 - Load management as “spinning” reserve
- What to do with storage
 - Use it sparingly until costs come down
- Stop thinking about base and peak loads
 - Flexibility is the buzzword